

# NAKKA

The Choice Of Life

## DC Frequency Conversion Fan

Bionic Natural Wind



# NAKKA

NAKKA Environmental Appliance Technology Co., Ltd  
Add: No.3 Zhongjian road, zhongyong industrial area, Leliu Town, Foshan  
City, Guangdong Province

Tel: 86-0757-25556223 E: [nakka@nakka.cn](mailto:nakka@nakka.cn)

[www.nakka.net](http://www.nakka.net)

[www.nakka.net](http://www.nakka.net)



# NAKKA

## COMPANY PROFILE

NAKKA Smart DC Technology and products is a manufacturing enterprise that focuses on production and development of high technology smart appliances primarily with household floor fans, commercial, industrial and ventilation fans.

With a quality oriented attitude, innovative and pragmatic spirit of research and development within the Research and Development team our company has successfully developed and patented a DC (Direct Current) motor fan to be an industry leader. What makes this DC motor unique is it is more energy efficient, low noise, smooth operation which allows NAKKA products to last longer than other electric fans.

THE CHOICE OF LIFE



CE RoHS ERP RED  
Energy-related Products

[www.nakka.net](http://www.nakka.net)



## OUR CERTIFICATION







# Fully Sealed Smart DC Motor 20 hours per day

Moisture proof | Dust-proof | Energy conservation | Long-lasting

Energy Consumption Of Industrial Fan Per Month

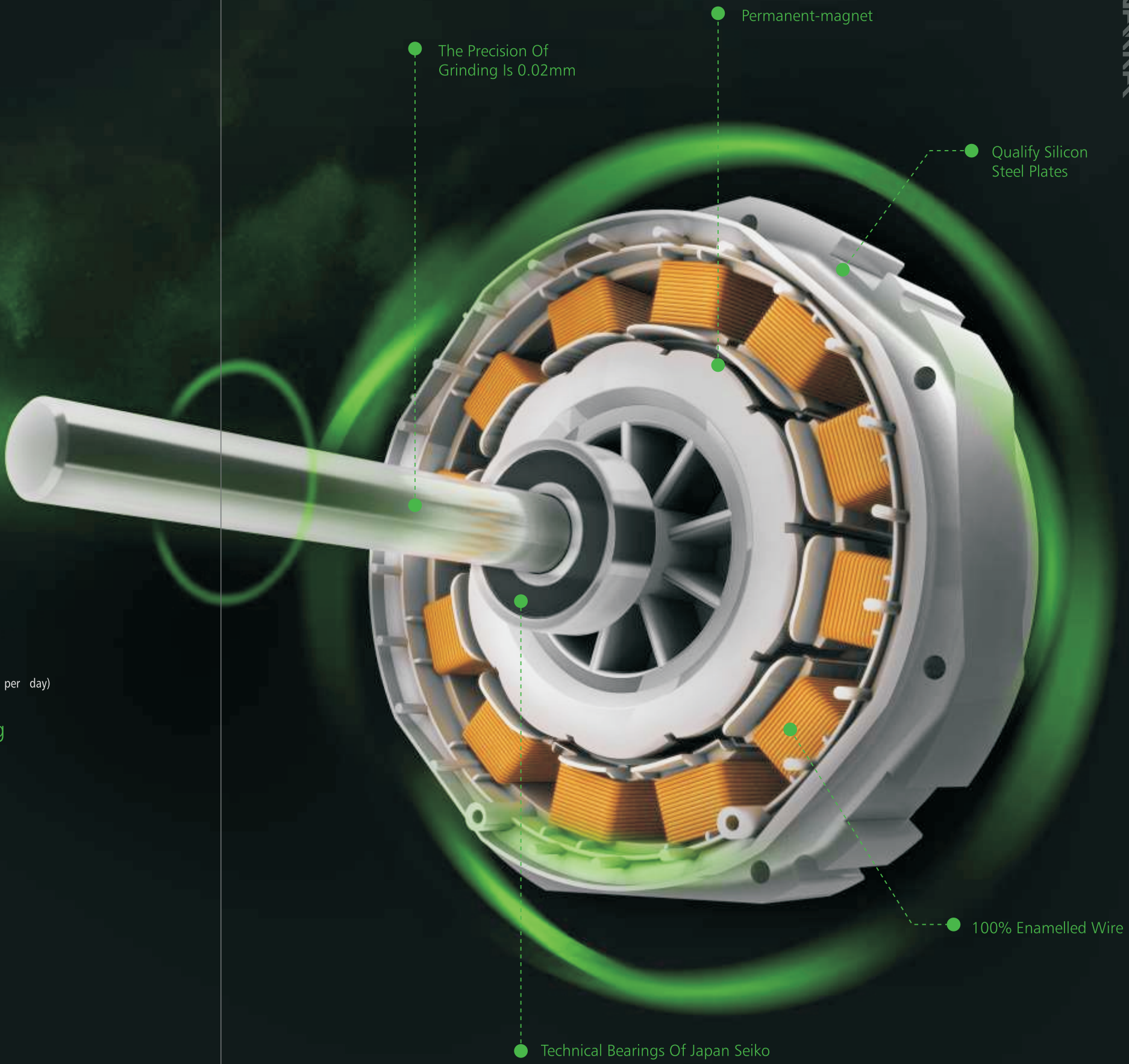
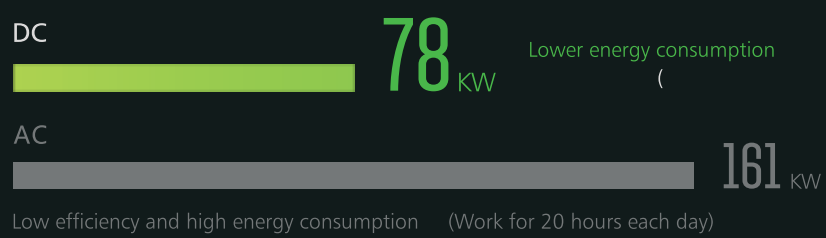



# DC motor

The sine wave noise reduction technology makes the motor work more quiet.

Sine Wave Schematic Diagram

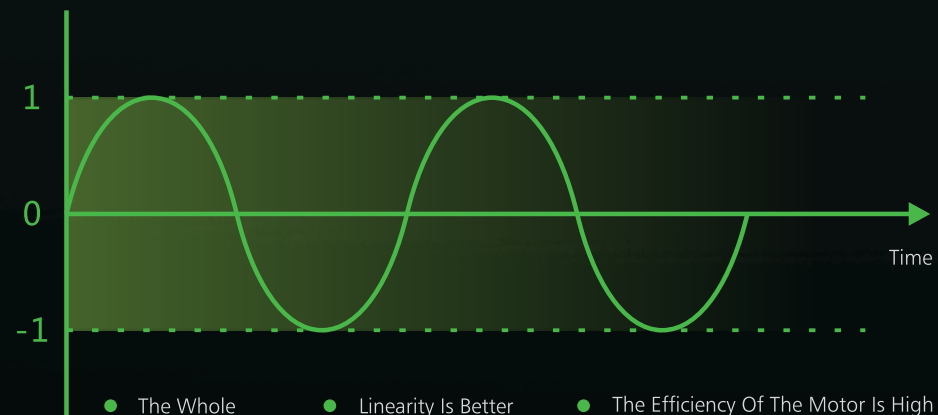

- The Whole Course Is Quiet
- Linearity Is Better Than Square Wave
- The Efficiency Of The Motor Is High And The Waveform Is More Consistent With The Working Principle Of The Motor

Square Wave Schematic Diagram



- Big Shock When Starting
- Large Electromagnetic Sound
- Low Efficiency

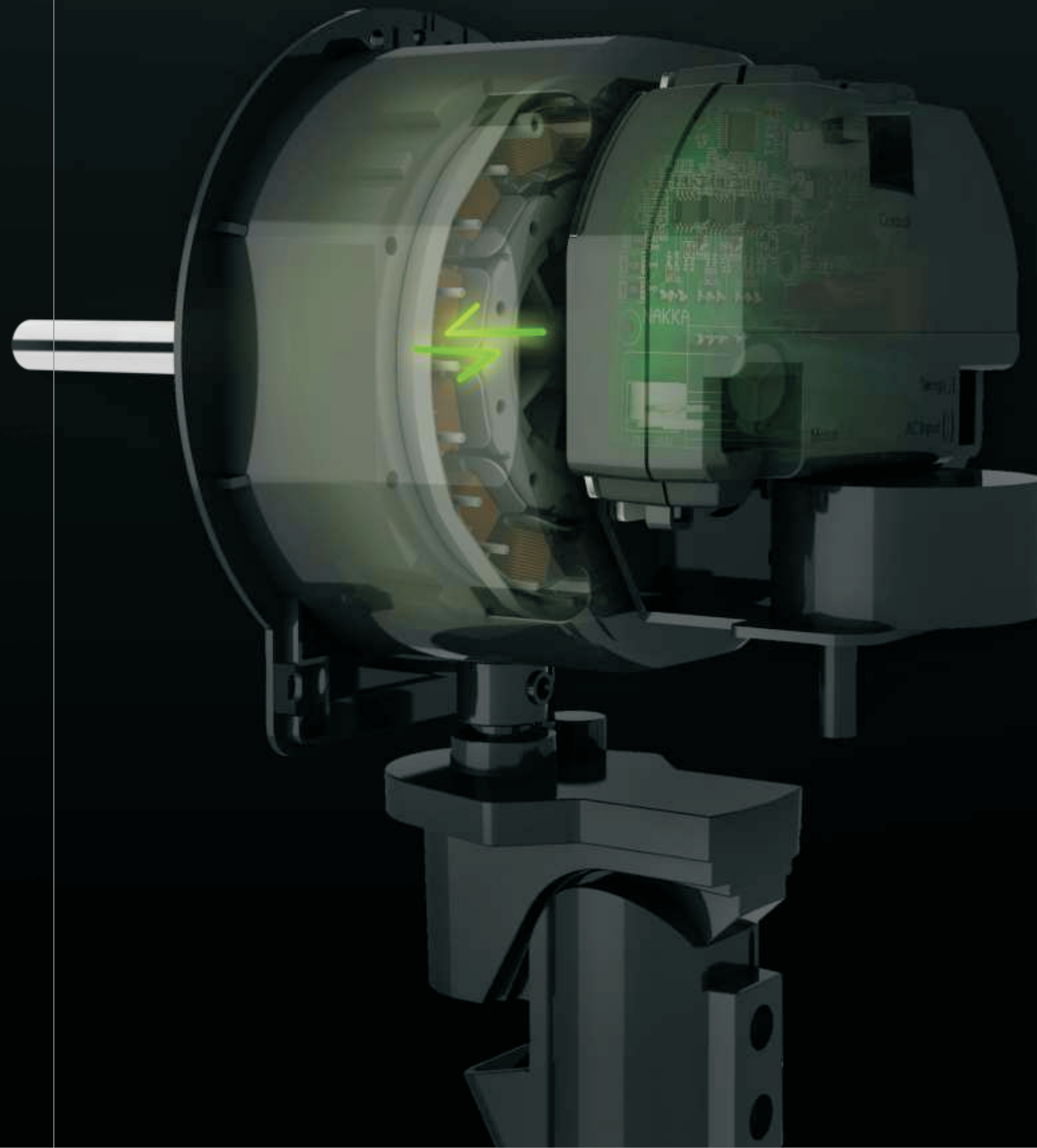



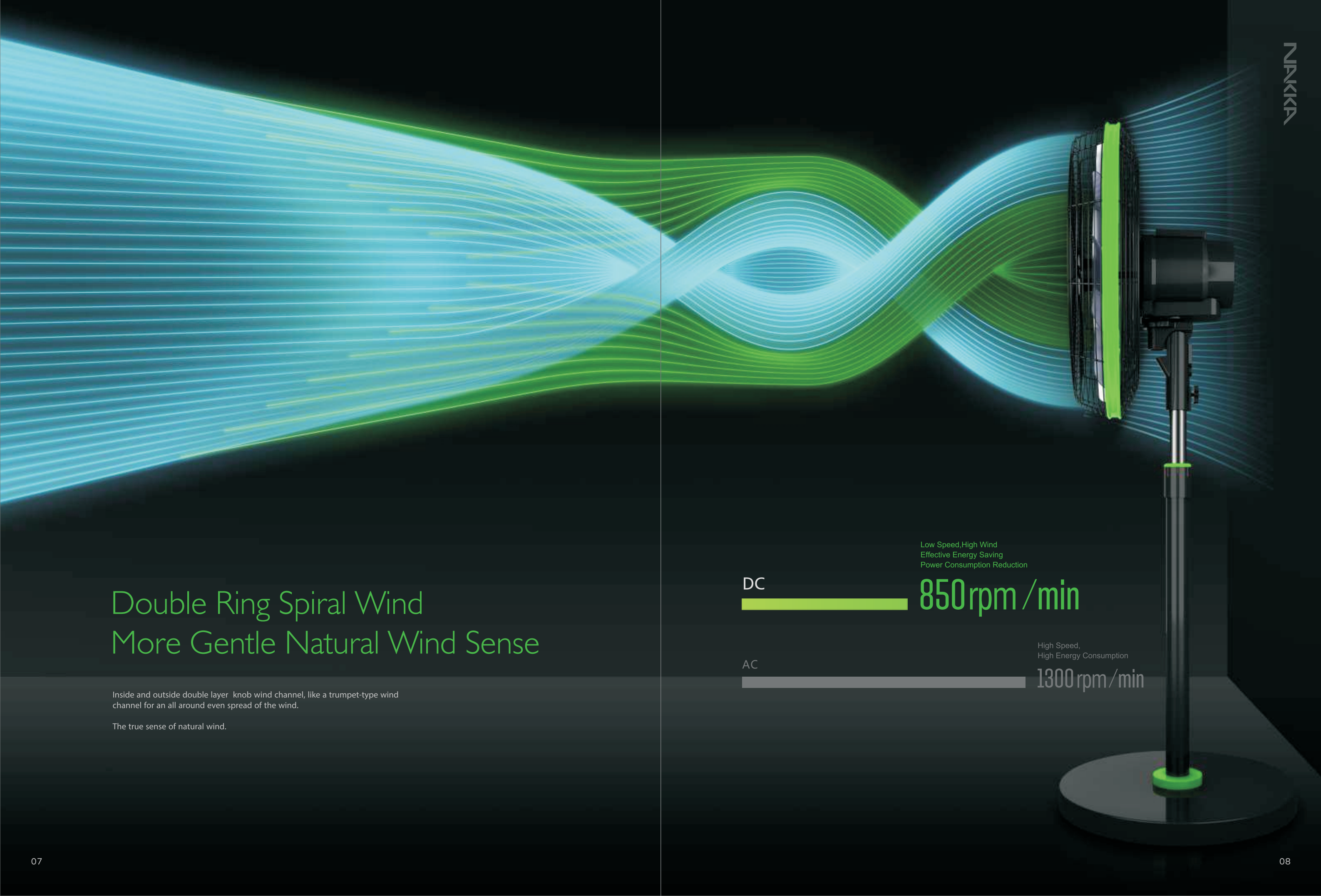

# Double Ring Spiral Wind More Gentle Natural Wind Sense

Inside and outside double layer knob wind channel, like a trumpet-type wind channel for an all around even spread of the wind.

The true sense of natural wind.

Low Speed, High Wind  
Effective Energy Saving  
Power Consumption Reduction

DC



850 rpm / min

AC

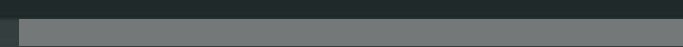

High Speed,  
High Energy Consumption

1300 rpm / min





# Disordered Frequency Conversion Bionic Natural Wind

The three-dimensional smooth and disorderly wind shows the wind speed, and the air volume is fast and slow. Strong, weak, random, not repeated, but it is the closest to the natural world.

Air volume frequency 600 times per minute

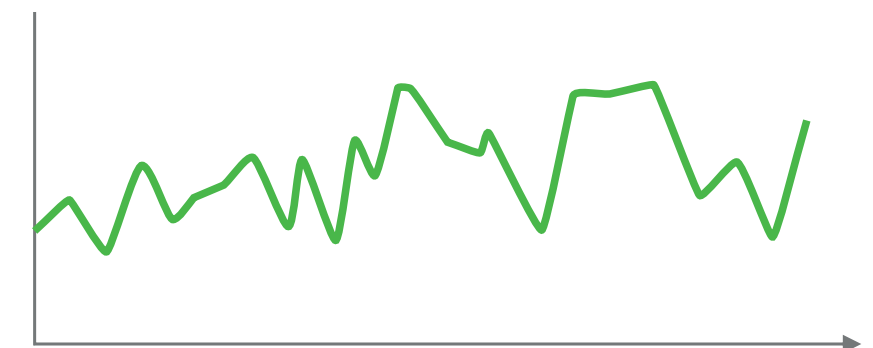

Frequency conversion bionic natural  
wind equation algorithm

Time





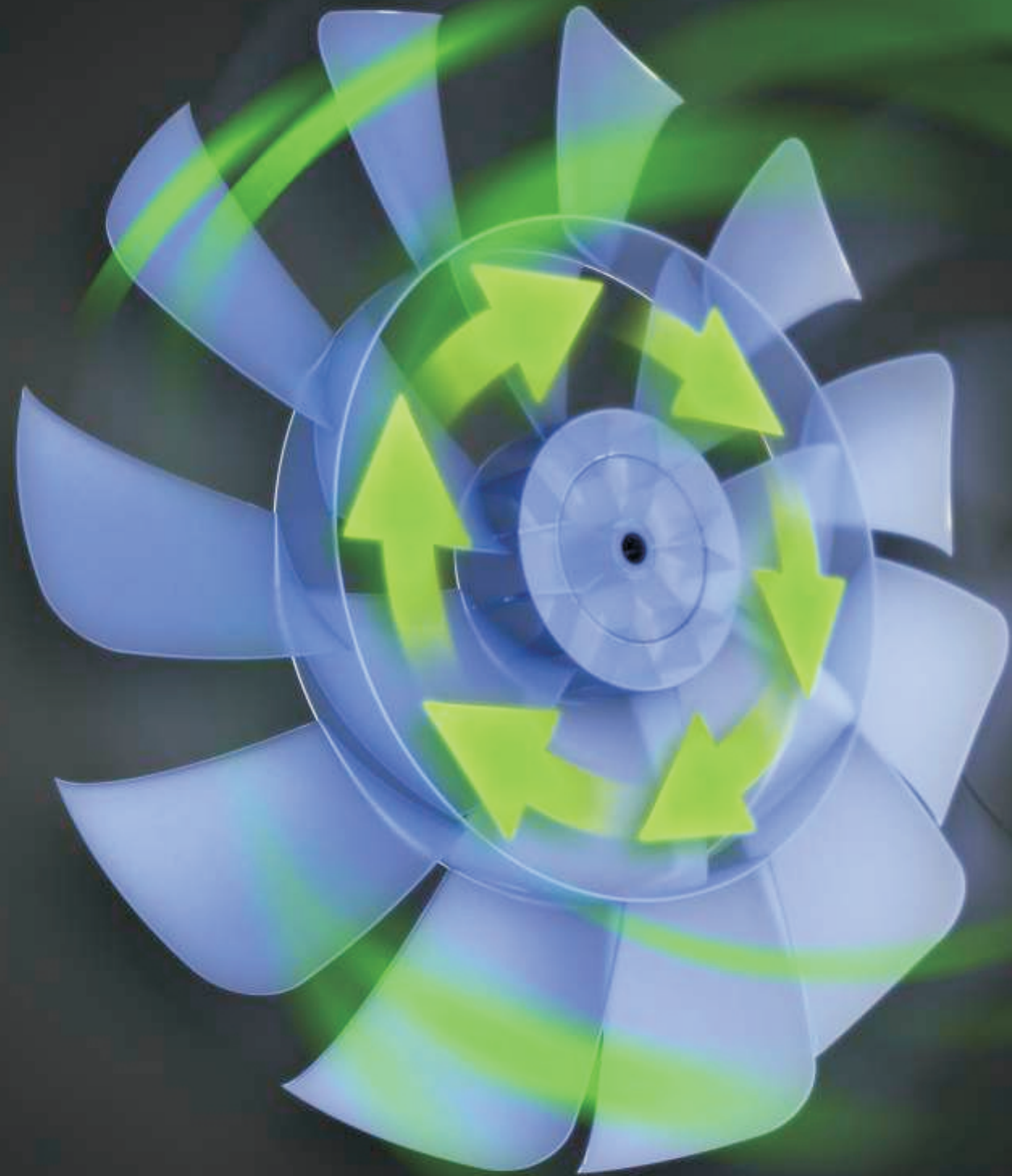

# 18 Blades Design Mute Technique

The wind cutting is more uniform, the wind is soft and the air supply is wider.

18 Blade Air Volume

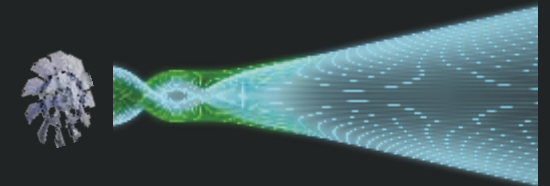

5 Blade Air Volume

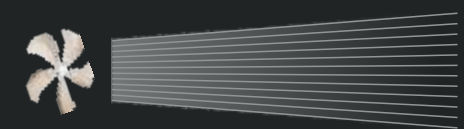



# Wide-angle Air Supply

Wide-angled shaped air supply angle is up to 120 degrees enables every person in the room, where ever located enjoy the cool breeze and feel from theEC fan.



Up And Down

35°



Shake Your Head

90°



Extended Height

27cm



# Remote Control

Wireless remote control uses 433Hz radio remote control technology. The Smart DC fan can effectively be controlled over 20 meters in an open area.

Equipped with a magnetic device for easy storage on the face of the DC fan.

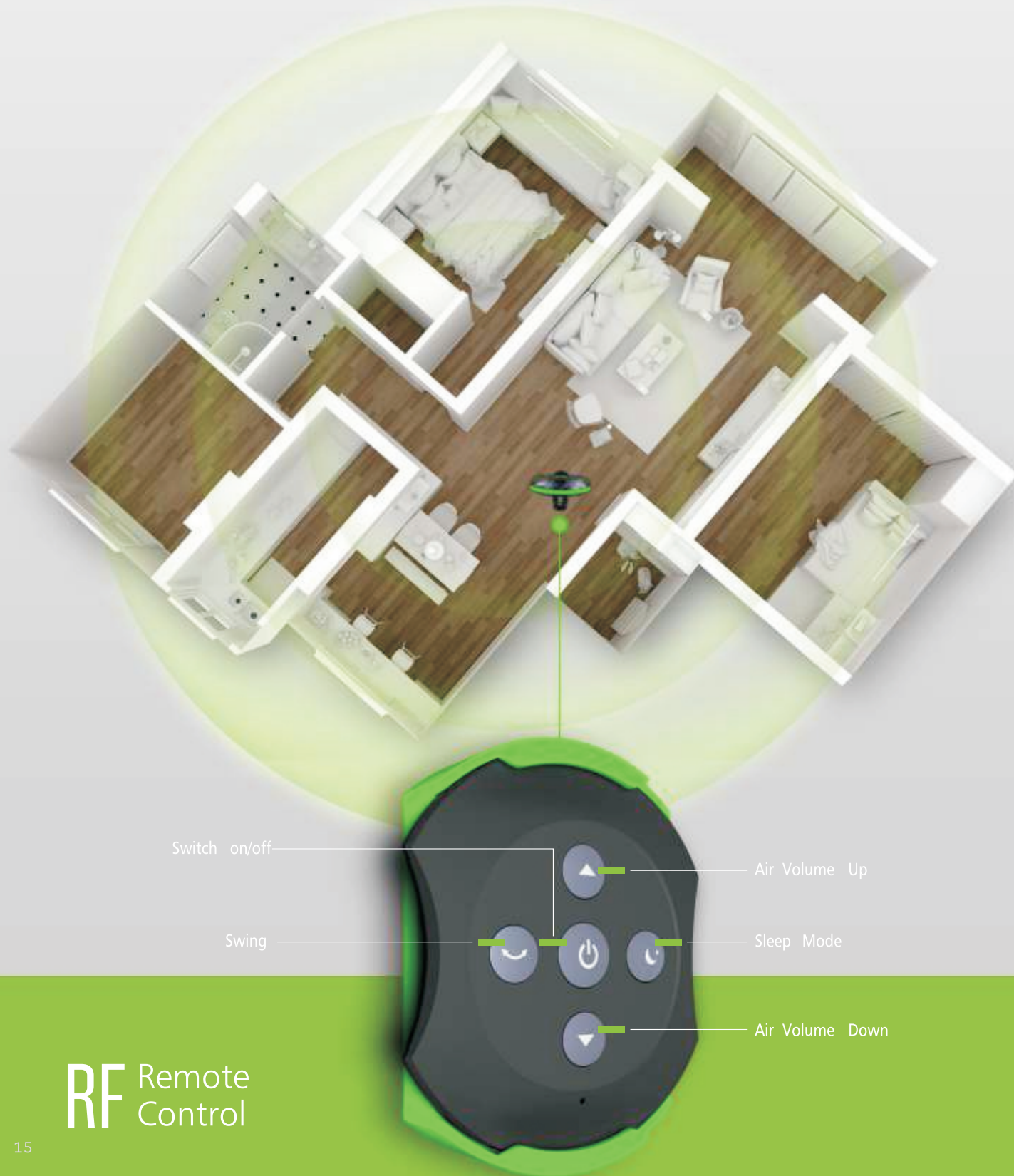

**RF** Remote Control

Magnet



**Unique Remote Control holder design**



# Multi-protection System

Overcurrent protection | Overvoltage protection | Motor blockage protect

Patented Fan Grill Net Cover with a circular structure, double-track sided frame with safety lock for additional protection for smaller hands and fingers

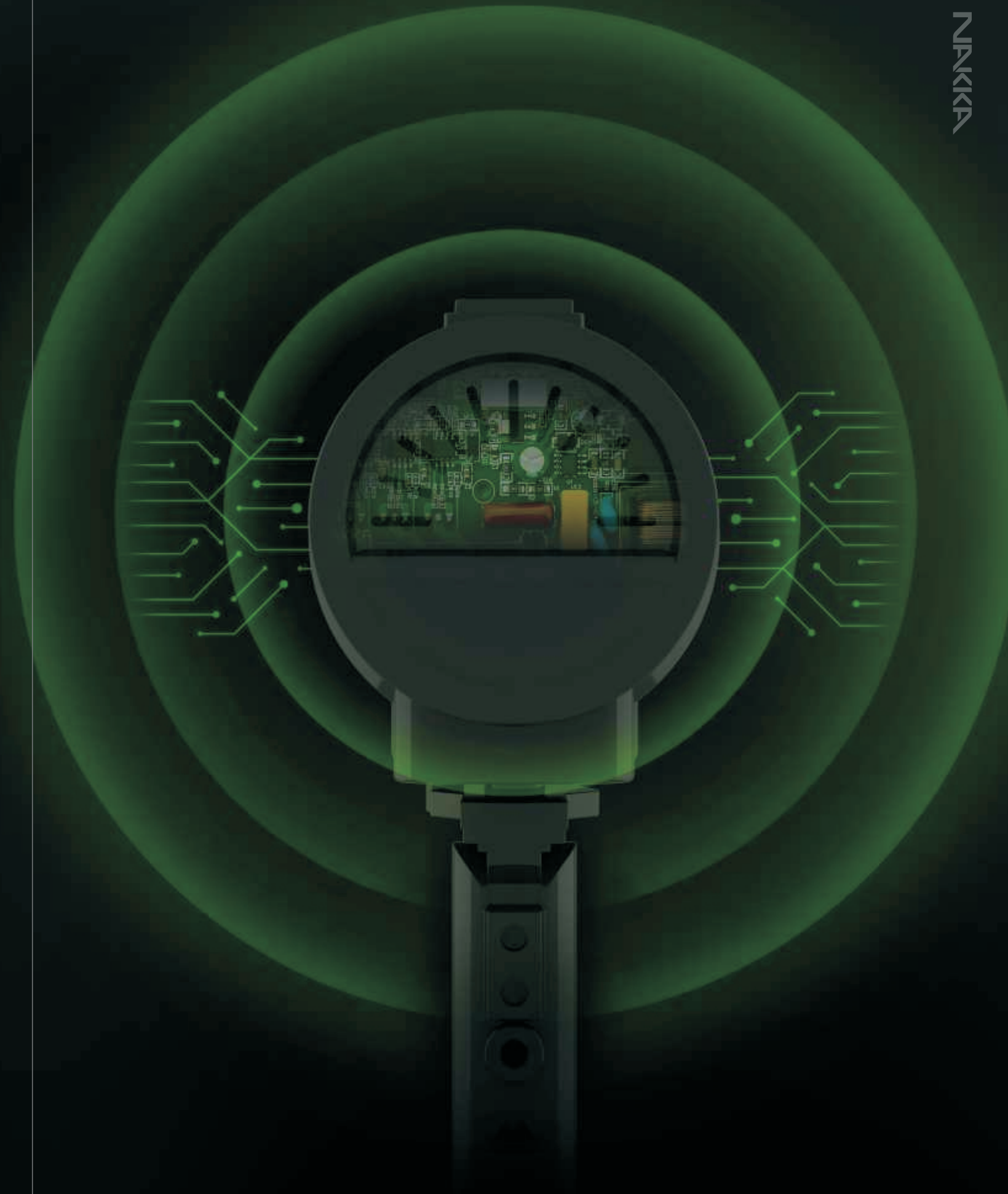
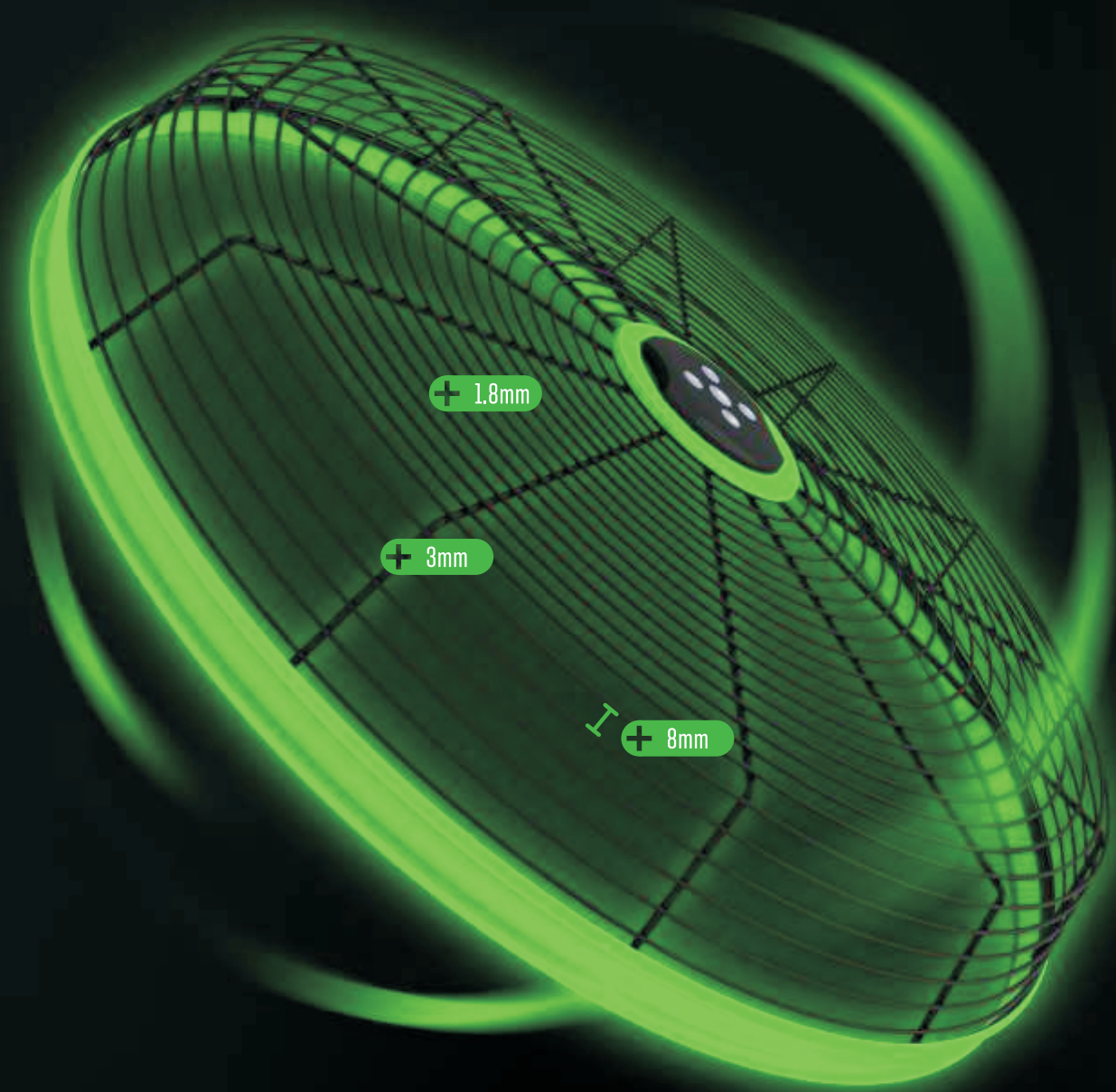



## A Quiet Time That Is Not Disturbed

Undisturbed And Peaceful Sleep  
Operating With Low Noise, Soft And Quiet.

The combination of gentle and natural wind and a comfortable environment  
makes you feel as if you are in nature.





# Intelligent Timer Setting

An automatic shutdown time up to 9 hours, depending on your current room environment to ensure a more comfortable experience.



# Intelligent Control

3 Different Type Of Wind Function  
6 Levels Of Wind Speed

RF REMOTE CONTROL

WiFi



6 Gear Speed Adjustable



Natural wind



Sleep wind





**Smart DC  
Commercial Fan  
Series**





Model: FS45-DC17ARL

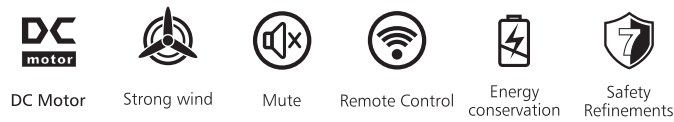

|                             |                         |
|-----------------------------|-------------------------|
| Size                        | 18 inch (450mm)         |
| Rated power                 | 1                       |
| Rated voltage(V)            | 200-240V/100-120V       |
| Maximum wind volume         | 167 m <sup>3</sup> /min |
| Fan sound power level       | 56db                    |
| Adjustable in height        | 108-135cm               |
| Left&right air supply angle | 90°                     |
| Up&down air supply angle    | 35°                     |
| Controler frequency         | 433Hz                   |

|              |                             |
|--------------|-----------------------------|
| Gross weight | 11.6kg                      |
| Net weight   | 9.7kg                       |
| Packing size | 52*35*53cm 73.5*19.5*52.5cm |

|                |     |     |
|----------------|-----|-----|
| 20 GP capacity | 256 | 419 |
| 40 GP capacity | 520 | 838 |
| 40 HC capacity | 604 | 959 |



RF REMOTE CONTROL



Model: FS45D-DC17ARL

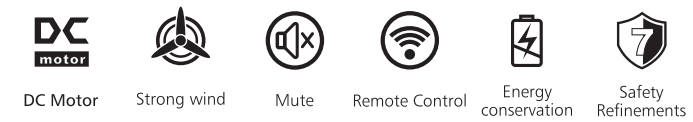

|                             |                           |
|-----------------------------|---------------------------|
| Size                        | 18 inch (450mm)*2         |
| Rated power                 | 18W-180W                  |
| Rated voltage(V) 8W-90W     | 200-240V/100-120V         |
| Maximum wind volume         | 167*2 m <sup>3</sup> /min |
| Fan sound power level       | 56*2 db                   |
| Adjustable in height        | 155-170cm                 |
| Left&right air supply angle | 90°                       |
| Up&down air supply angle    | 35°                       |
| Controler frequency         | 433Hz                     |

|              |              |
|--------------|--------------|
| Gross weight | 20.8kg       |
| Net weight   | 18.1kg       |
| Packing size | 83*24.5*54cm |

|                |     |
|----------------|-----|
| 20 GP capacity | 252 |
| 40 GP capacity | 508 |
| 40 HC capacity | 568 |

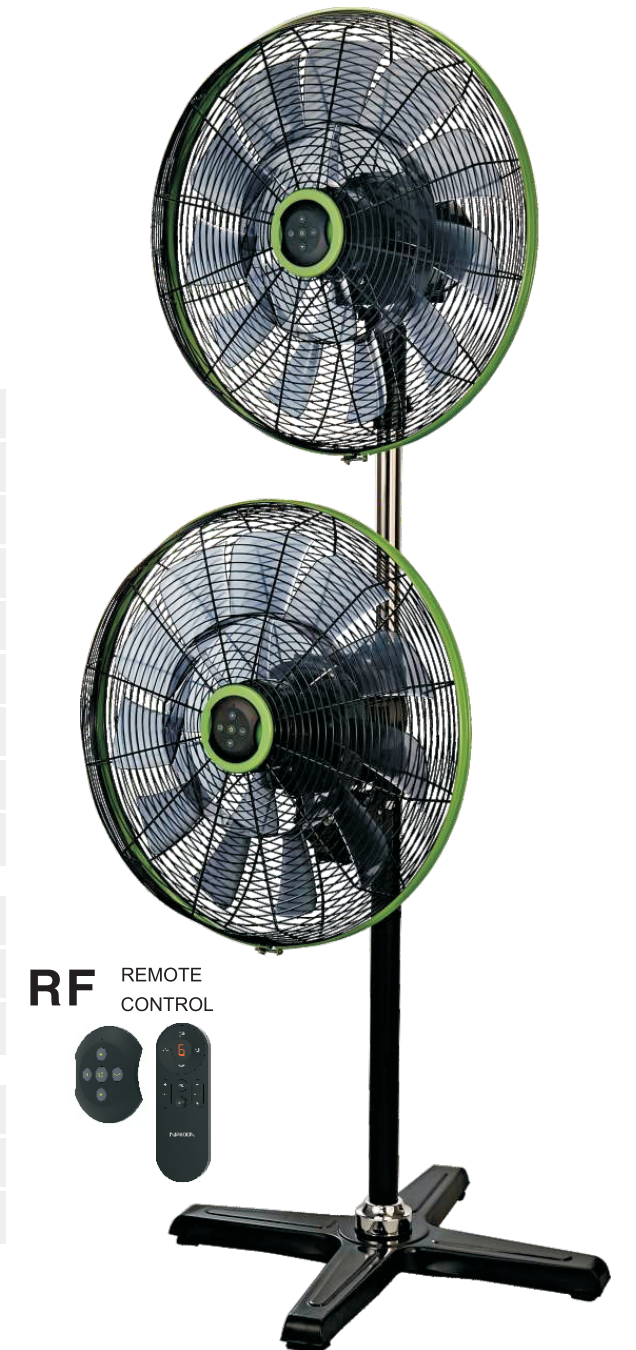







RF REMOTE CONTROL





Model: FM45-DC17ARL

-  DC Motor
-  Strong wind
-  Mute
-  Remote Control
-  Energy conservation
-  Safety Refinements

|                       |                         |
|-----------------------|-------------------------|
| Size                  | 18 inch (450mm)         |
| Rated power           | 160W                    |
| Rated voltage(V)      | 200-240                 |
| Maximum wind volume   | 167 m <sup>3</sup> /min |
| Fan sound power level | 56db                    |
| Water tank volume     | 2 liter                 |
| Continuous spray      | 5-8 hours               |
| Effective area        | 20 m                    |
| Spray droplet         | 0.05-0.20mg             |
| Controler frequency   | 433Hz                   |
| Gross weight          | 14.5kg                  |
| Net weight            | 12kg                    |
| Packing size          | 52*50*52cm              |
| 20 GP capacity        | 176                     |
| 40 GP capacity        | 384                     |
| 40 HC capacity        | 480                     |



Model: FS45-DC17BL / FS50-DC17BL

-  DC Motor
-  Strong wind
-  Mute
-  Control Panel
-  Energy conservation
-  Safety Refinements

|                             | FS45-DC17BL             | FS50-DC17BL             |
|-----------------------------|-------------------------|-------------------------|
| Size                        | 18 inch (450mm)         | 20 inch (500mm)         |
| Rated power                 | 4W-90W                  | 4W-90W                  |
| Rated voltage(V) 87         | 200-240V/100-120V       |                         |
| Maximum wind volume         | 167 m <sup>3</sup> /min | 167 m <sup>3</sup> /min |
| Fan sound power level       | 63db                    | 63db                    |
| Adjustable in height        | 108-135cm               |                         |
| Left&right air supply angle | 90°                     |                         |
| Up&down air supply angle    | 35°                     |                         |
| Gross weight                | 10.8kg                  | 12kg                    |
| Net weight                  | 8.9kg                   | 10.3kg                  |
| Packing size                | 73*19*52.5cm            | 79*20*58cm              |
| 20 GP capacity              | 419                     | 324                     |
| 40 GP capacity              | 838                     | 660                     |
| 40 HC capacity              | 959                     | 715                     |





Model: FTS45-DC17ARL

- Strong wind
- Mute
- Remote Control
- DC Motor
- Energy conservation
- Safety Refinements

RF REMOTE CONTROL



|                             |                  |                     |                         |
|-----------------------------|------------------|---------------------|-------------------------|
| Size                        | 18 inch (450mm)  | Rated voltage(V)    | 200-240V/100-120V       |
| Rated power                 | 18W-90W          | Maximum wind volume | 167 m <sup>3</sup> /min |
| Fan sound power level       | 56db             | 20 GP capacity      | 419                     |
| Adjustable in height        | 58cm             | 40 GP capacity      | 838                     |
| Left&right air supply angle | 90°              | 40 HC capacity      | 959                     |
| Up&down air supply angle    | 35°              |                     |                         |
| Controler frequency         | 433Hz            |                     |                         |
| Gross weight                | 11.6kg           |                     |                         |
| Net weight                  | 9.7kg            |                     |                         |
| Packing size                | 73.5*19.5*52.5cm |                     |                         |

Model: FTS45-DC17BL

- Strong wind
- Mute
- Controle Panel
- DC Motor
- Energy conservation
- Safety Refinements

RF REMOTE CONTROL



(Optional)



|                             |                  |                     |                         |
|-----------------------------|------------------|---------------------|-------------------------|
| Size                        | 18 inch (450mm)  | Rated voltage(V)    | 200-240V/100-120V       |
| Rated power                 | 4W-90W           | Maximum wind volume | 167 m <sup>3</sup> /min |
| Fan sound power level       | 63db             | 20 GP capacity      | 419                     |
| Adjustable in height        | 58cm             | 40 GP capacity      | 838                     |
| Left&right air supply angle | 90°              | 40 HC capacity      | 959                     |
| Up&down air supply angle    | 35°              |                     |                         |
| Gross weight                | 11.6kg           |                     |                         |
| Net weight                  | 9.7kg            |                     |                         |
| Packing size                | 73.5*19.5*52.5cm |                     |                         |



Model: FW45-DC17ARL

- Strong wind
- Mute
- Remote Control
- DC Motor
- Energy conservation
- Safety Refinements

RF REMOTE CONTROL



|                             |                 |                     |                         |
|-----------------------------|-----------------|---------------------|-------------------------|
| Size                        | 18 inch (450mm) | Rated voltage(V)    | 200-240V/100-120V       |
| Rated power                 | 18W-90W         | Maximum wind volume | 167 m <sup>3</sup> /min |
| Fan sound power level       | 56db            | 20 GP capacity      | 352                     |
| Left&right air supply angle | 90°             | 40 GP capacity      | 720                     |
| Up&down air supply angle    | 35°             | 40 HC capacity      | 899                     |
| Controler frequency         | 433Hz           |                     |                         |
| Gross weight                | 10.8kg          |                     |                         |
| Net weight                  | 8.9kg           |                     |                         |
| Packing size                | 52.5*29*53.5cm  |                     |                         |

Model: FW45-DC17BRL

- Strong wind
- Mute
- Remote Control
- DC Motor
- Energy conservation
- Safety Refinements

RF REMOTE CONTROL

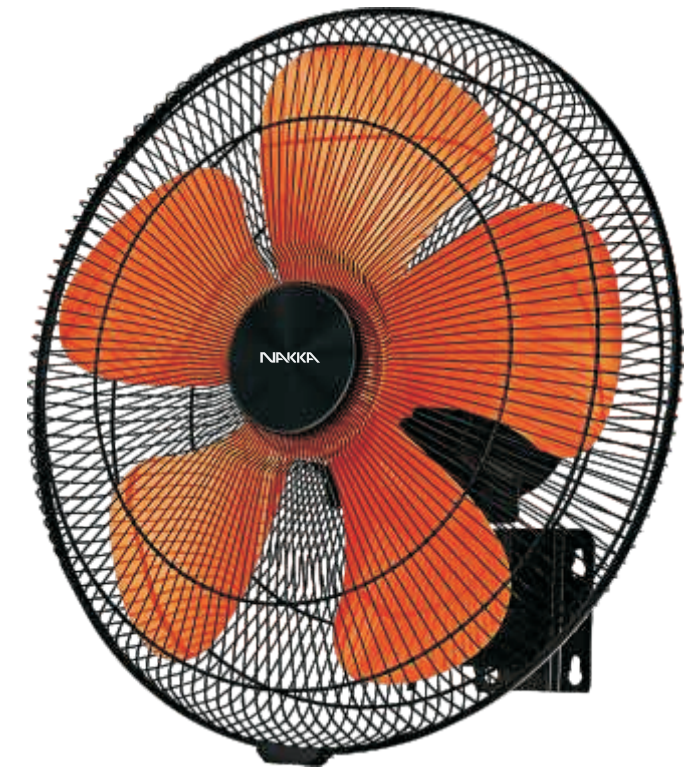

|                             |                  |                     |                         |
|-----------------------------|------------------|---------------------|-------------------------|
| Size                        | 18 inch (450mm)  | Rated voltage(V)    | 200-240V/100-120V       |
| Rated power                 | 4W-90W           | Maximum wind volume | 167 m <sup>3</sup> /min |
| Fan sound power level       | 56db             | 20 GP capacity      | 352                     |
| Left&right air supply angle | 90°              | 40 GP capacity      | 720                     |
| Up&down air supply angle    | 35°              | 40 HC capacity      | 899                     |
| Controler frequency         | 433Hz            |                     |                         |
| Gross weight                | 10.8kg           |                     |                         |
| Net weight                  | 8.9kg            |                     |                         |
| Packing size                | 52.5*27.5*53.5cm |                     |                         |



Smart DC  
Industrial Fan  
Series





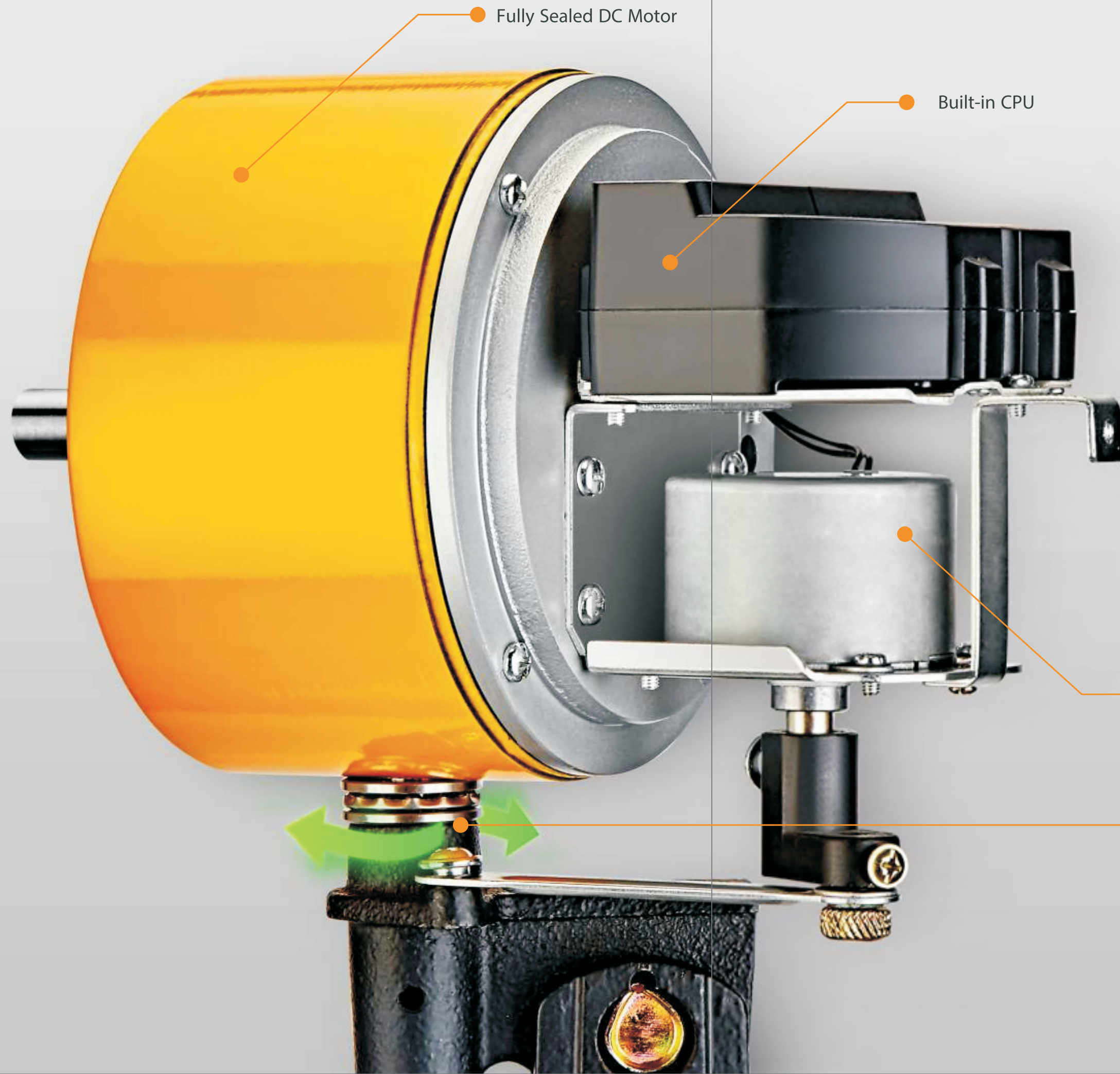

Fully Sealed DC Motor

Built-in CPU

## Science and Electronic Technology

Using high-torque synchronous motor electronic control Technology, the swing of the head angle can be freely controlled.

The plate bearing is included in the design to support the main patented DC motor, Which greatly reduces the friction generated by the fan pendulum so that the synchronous motor has less stress and prolongs the service life of NAKKA smart DC commercial and industrial fans.



Model: FS75-DC17ARL

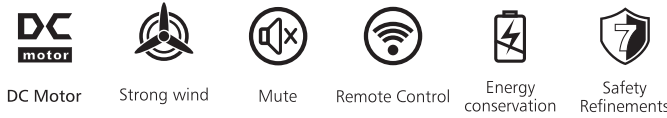

Performance

Pole Adjustable pole  
 Base 8kg plastic pedestal (can past 12° ramp testing )  
 Grill 30 inch 24 lines strong grill (pass the finger testing )  
 Blade 30 inch 3 blades Aluminum design ( lowest noise , max air volume)  
 Power Cable 3\*0.75mm 100% copper power line( The length of the power cord is 1.8m)

|                             |                   |
|-----------------------------|-------------------|
| Size                        | 30 inch (750mm)   |
| Rated power                 | 25W-130W          |
| Rated voltage(V)            | 200-240V/100-120V |
| Maximum wind volume         | 314.6m³/min       |
| Fan sound power level       | 72db              |
| Left&right air supply angle | 75°               |
| Up&down air supply angle    | 40°               |
| Adjustable in height        | 151-168cm         |

|                       |  |
|-----------------------|--|
| Gross weight          | 24kg   |
| Net weight            | 21.2kg   |
| Packing size          | 82.5*8*82.5cm<br>25*19*32cm<br>52.5*8.5*52.5cm<br>7*7*98cm |
| One fan one container | 85*20.5*85cm   |

|                |     |     |
|----------------|-----|-----|
| 20 GP capacity | 300 | 172 |
| 40 GP capacity | 650 | 324 |
| 40 HC capacity | 740 | 408 |

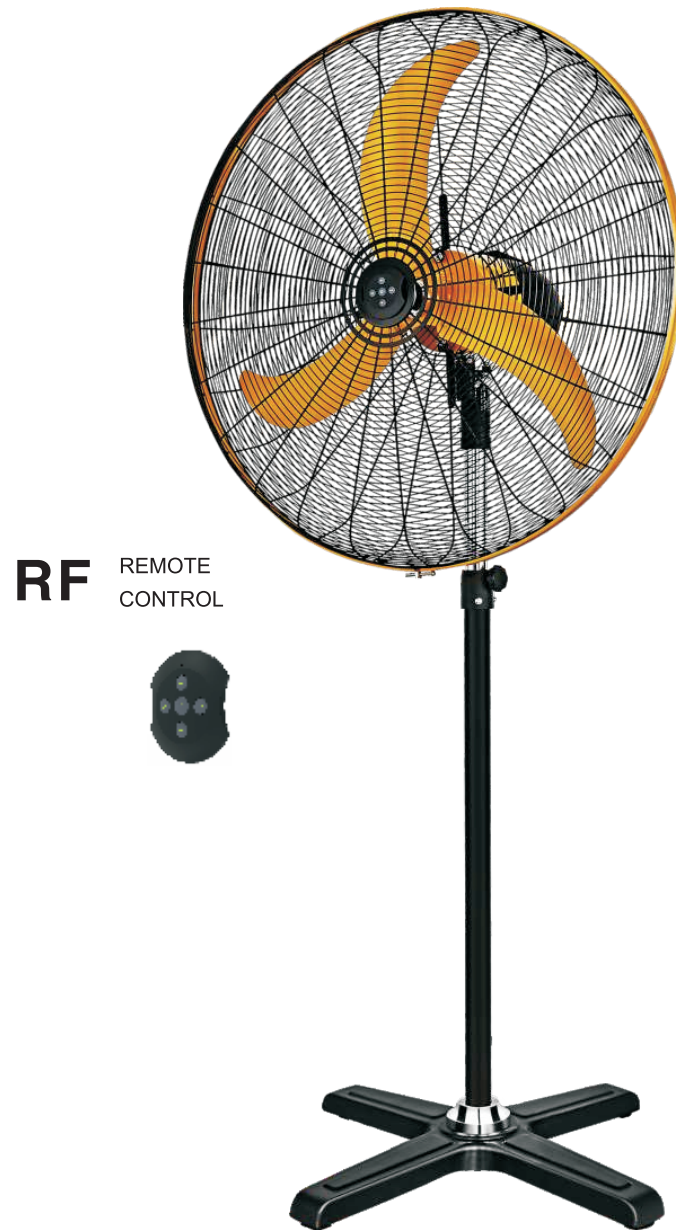

Model: FS65-DC17BL

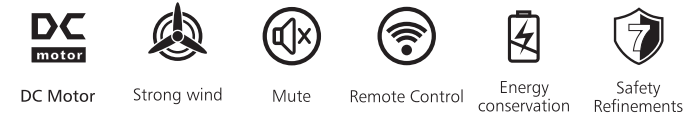

Performance

Pole Adjustable pole  
 Base 7kg plastic pedestal (can past 12° ramp testing )  
 G 26 inch 16 lines strong grill (pass the finger testing )  
 Blade 26 inch 3 blades Aluminum design ( lowest noise , max air volume)  
 Power Cable 3\*0.75mm 100% copper power line( The length of the power cord is 1.8m)

|                             |                   |
|-----------------------------|-------------------|
| Size                        | 26 inch (650mm)   |
| Rated power                 | 20W-130W          |
| Rated voltage(V)            | 200-240V/100-120V |
| Maximum wind volume         | 251 m³/min        |
| Fan sound power level       | 63db              |
| Left&right air supply angle | 75°               |
| Up&down air supply angle    | 40°               |
| Adjustable in height        | 145-162cm         |

|                       |  |
|-----------------------|--|
| Gross weight          | 20.7kg   |
| Net weight            | 18.7kg   |
| Packing size          | 72*8*72cm<br>25*19*32cm<br>52.5*8.5*52.5cm<br>7*7*98cm |
| One fan one container | 97*21*73cm   |

|                |     |     |
|----------------|-----|-----|
| 20 GP capacity | 350 | 198 |
| 40 GP capacity | 730 | 402 |
| 40 HC capacity | 830 | 473 |





Model: FW75-DC17ARL

- DC Motor
- Strong wind
- Mute
- Remote Control
- Energy conservation
- Safety Refinements

Performance

Grill 30 inch 24 lines strong grill (pass the finger testing)  
 Blade 30 inch 3 blades Aluminum design ( lowest noise , max air volume)  
 Power Cable 3\*0.75mm 100% copper power line( The length of the power cord is 1.8m)

|                             |                   |
|-----------------------------|-------------------|
| Size                        | 30 inch (750mm)   |
| Rated power                 | 25W-130W          |
| Rated voltage(V)            | 200-240V/100-120V |
| Maximum wind volume         | 72db              |
| Fan sound power level       | 314m³/min         |
| Left&right air supply angle | 75°               |
| Up&down air supply angle    | 40°               |

|                 |                               |
|-----------------|-------------------------------|
| Gross weight    | 14.14kg                       |
| Net weight      | 11.9kg                        |
| Packing size    | 82.5*8*82.5cm<br>25.5*19*32cm |
| One fan one box | 85*20.5*85 cm                 |

|                |      |     |
|----------------|------|-----|
| 20 GP capacity | 435  | 180 |
| 40 GP capacity | 900  | 376 |
| 40 HC capacity | 1000 | 471 |



RF REMOTE CONTROL



Model: FW65-DC17ARL

- DC Motor
- Strong wind
- Mute
- Remote Control
- Energy conservation
- Safety Refinements

Performance

Grill 26 inch 12 lines strong grill  
 Blade 26 inch 3 blades Aluminum design ( lowest noise , max air volume)  
 Power Cable 3\*0.75mm 100% copper power line( The length of the power cord is 1.8m)

|                             |                   |
|-----------------------------|-------------------|
| Size                        | 26 inch (650mm)   |
| Rated power                 | 20W-130W          |
| Rated voltage(V)            | 200-240V/100-120V |
| Maximum wind volume         | 72db              |
| Fan sound power level       | 314m³/min         |
| Left&right air supply angle | 75°               |
| Up&down air supply angle    | 40°               |

|                 |                           |
|-----------------|---------------------------|
| Gross weight    | 10.72kg                   |
| Net weight      | 9.65kg                    |
| Packing size    | 72*8*72cm<br>25.5*19*32cm |
| One fan one box | 97*21*73cm                |

|                |     |     |
|----------------|-----|-----|
| 20 GP capacity | 350 | 198 |
| 40 GP capacity | 730 | 402 |
| 40 HC capacity | 830 | 473 |

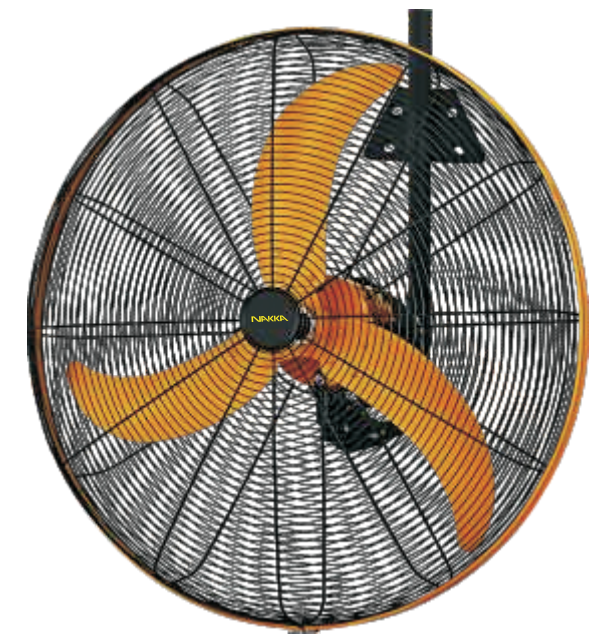

RF REMOTE CONTROL





Model: FD60-DC20ARL-P



Ip44 WATERPROOF FAN

|                    |   |
|--------------------|---|
| Size               | 24 INCH                                   |
| Rated power        | 110W                                      |
| Rated voltage(V)   | 200-240V/100-120V                         |
| Oscillation Degree | 360°                                      |
| Control panel      | touched control panel                     |
| Function           | 6 wind speeds, 9h timer, strong wind mode |

|              |              |
|--------------|--------------|
| Gross weight | 14.5kg       |
| Net weight   | 12.5kg       |
| Packing size | 76.5*24*78cm |

|                |     |
|----------------|-----|
| 20 GP capacity | 195 |
| 40 GP capacity | 411 |
| 40 HC capacity | 459 |



RF REMOTE CONTROL



Model: FW50-DC20ARL-P

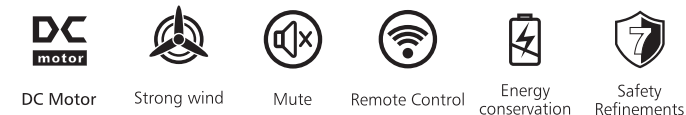

Ip44 WATERPROOF FAN

|                    |   |
|--------------------|---|
| Size               | 20 INCH                                   |
| Rated power        | 135W                                      |
| Rated voltage(V)   | 200-240V/100-120V                         |
| Oscillation Degree | 360°                                      |
| Control panel      | touched control panel                     |
| Fan mode           | 6 wind speeds, 9h timer, strong wind mode |

|              |            |
|--------------|------------|
| Gross weight | 7.8kg      |
| Net weight   | 6.6kg      |
| Packing size | 62*20*63cm |

|                |     |
|----------------|-----|
| 20 GP capacity | 369 |
| 40 GP capacity | 768 |
| 40 HC capacity | 929 |



RF REMOTE CONTROL





Model: FD60-DC20ARL

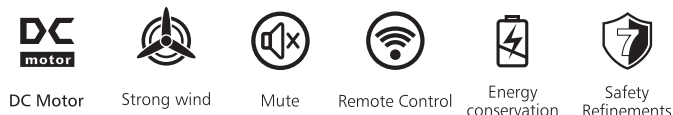

24 Inch Drum Fan

|                    |   |
|--------------------|---|
| Size               | 24 INCH                                   |
| Rated power        | 110W                                      |
| Rated voltage(V)   | 200-240V/100-120V                         |
| Oscillation Degree | 360°                                      |
| Control panel      | touched control panel                     |
| Function           | 6 wind speeds, 9h timer, strong wind mode |

|              |              |
|--------------|--------------|
| Gross weight | 14.5kg       |
| Net weight   | 12.5kg       |
| Packing size | 76.5*24*78cm |

|                |     |
|----------------|-----|
| 20 GP capacity | 195 |
| 40 GP capacity | 411 |
| 40 HC capacity | 459 |



RF REMOTE CONTROL



Model: FD75-DC20ARL

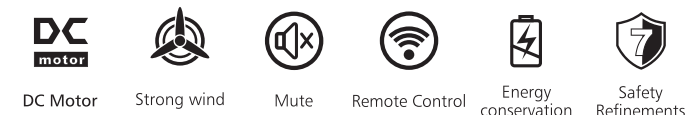

30 Inch Drum Fan

|                    |   |
|--------------------|---|
| Size               | 30 inch                                   |
| Rated power        | 150W                                      |
| Rated voltage(V)   | 200-240V/100-120V                         |
| Oscillation Degree | 360°                                      |
| Control panel      | touched control panel                     |
| Fan mode           | 6 wind speeds, 9h timer, strong wind mode |

|              |            |
|--------------|------------|
| Gross weight | 16.9kg     |
| Net weight   | 14.9kg     |
| Packing size | 94*24*96cm |

|                |     |
|----------------|-----|
| 20 GP capacity | 132 |
| 40 GP capacity | 272 |
| 40 HC capacity | 296 |



RF REMOTE CONTROL





Model: FD90-DC20ARL

- DC Motor
- Strong wind
- Mute
- Remote Control
- Energy conservation
- Safety Refinements

36 Inch Drum Fan

|                    |   |
|--------------------|---|
| Size               | 36 inch                                   |
| Rated power        | 150W                                      |
| Rated voltage(V)   | 200-240V/100-120V                         |
| Oscillation Degree | 360°                                      |
| Control panel      | touched control panel                     |
| Function           | 6 wind speeds, 9h timer, strong wind mode |

|              |                |
|--------------|----------------|
| Gross weight | 23.4kg         |
| Net weight   | 21.9kg         |
| Packing size | 102.5*32*101cm |

|                |     |
|----------------|-----|
| 20 GP capacity | 92  |
| 40 GP capacity | 192 |
| 40 HC capacity | 206 |



RF REMOTE CONTROL



Model: FD105-DC20ARL

- DC Motor
- Strong wind
- Mute
- Remote Control
- Energy conservation
- Safety Refinements

42 Inch Drum Fan

|                    |   |
|--------------------|---|
| Size               | 42 inch                                   |
| Rated power        | 220W                                      |
| Rated voltage(V)   | 200-240V/100-120V                         |
| Oscillation Degree | 360°                                      |
| Control panel      | touched control panel                     |
| Function           | 6 wind speeds, 9h timer, strong wind mode |

|              |                |
|--------------|----------------|
| Gross weight | 38kg           |
| Net weight   | 36kg           |
| Packing size | 102.5*32*101cm |

|                |     |
|----------------|-----|
| 20 GP capacity | 64  |
| 40 GP capacity | 136 |
| 40 HC capacity | 156 |



RF REMOTE CONTROL





Smart DC  
Waterproof  
Fan Series



Model: FM65-DC19ARL



**Performance**

**Grill** 26 inch 12 lines strong grill  
**Blade** 26 inch 3 blades Aluminum design ( lowest noise , max air volume)  
**Power Cable** 3\*0.75mm 100% copper power line(The length of the power cord is 1.8m)

|                             |                          |
|-----------------------------|--------------------------|
| Size                        | 26 INCH (650mm)          |
| Rated power                 | 210W                     |
| Rated voltage(V)            | 200-240V/100-120V        |
| Maximum wind volume         | 314.5m <sup>3</sup> /min |
| Fan sound power level       | 72db                     |
| Left&right air supply angle | 75°                      |
| Up&down air supply angle    | 40°                      |
| Height                      | 1750mm                   |

|              |   |
|--------------|---|
| Gross weight | 23 kg                                   |
| Net weight   | 21.93 kg                                |
| Packing size | 113*19*11cm<br>56*40*35cm<br>72*12*72cm |

|                |         |
|----------------|---------|
| 20 GP capacity | 190 PCS |
| 40 GP capacity | 390 PCS |
| 40 HC capacity | 430 PCS |

RF REMOTE CONTROL



DC Frequency Conversion Fan

NANKKA

Model: FM75-DC19ARL

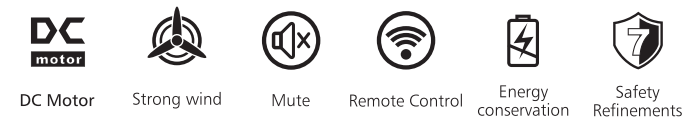

**Performance**

**Grill** 30 inch 12 lines strong grill  
**Blade** 30 inch 3 blades Aluminum design ( lowest noise , max air volume)  
**Power Cable** 3\*0.75mm 100% copper power line(The length of the power cord is 1.8m)

|                             |                          |
|-----------------------------|--------------------------|
| Size                        | 30 INCH (750mm)          |
| Rated power                 | 210W                     |
| Rated voltage(V)            | 200-240V/100-120V        |
| Maximum wind volume         | 314.5m <sup>3</sup> /min |
| Fan sound power level       | 72db                     |
| Left&right air supply angle | 75°                      |
| Up&down air supply angle    | 40°                      |
| Height                      | 1800mm                   |

|              |   |
|--------------|---|
| Gross weight | 24 kg                                   |
| Net weight   | 22.93 kg                                |
| Packing size | 113*19*11cm<br>56*40*35cm<br>82*12*82cm |

|                |         |
|----------------|---------|
| 20 GP capacity | 165 PCS |
| 40 GP capacity | 340 PCS |
| 40 HC capacity | 385 PCS |

RF REMOTE CONTROL





Smart DC  
Household  
Fan Series



Model: FW40-DC22ARL



|                  |  |
|------------------|--|
| Size             | 16 INCH  |
| Rated power      | 28W  |
| Rated voltage(V) | 200-240V/100-120V  |
| Control panel    | touched control panel  |
| Fan mode         | 9 wind speeds, 9h timer, strong wind mode, sleep mode, natural wind mode |
| Gross weight     | 4.13 kg  |
| Net weight       | 3.13 kg  |
| Packing size     | 49*17*58cm   |

|                |      |
|----------------|------|
| 20 GP capacity | 626  |
| 40 GP capacity | 1290 |
| 40 HC capacity | 1476 |

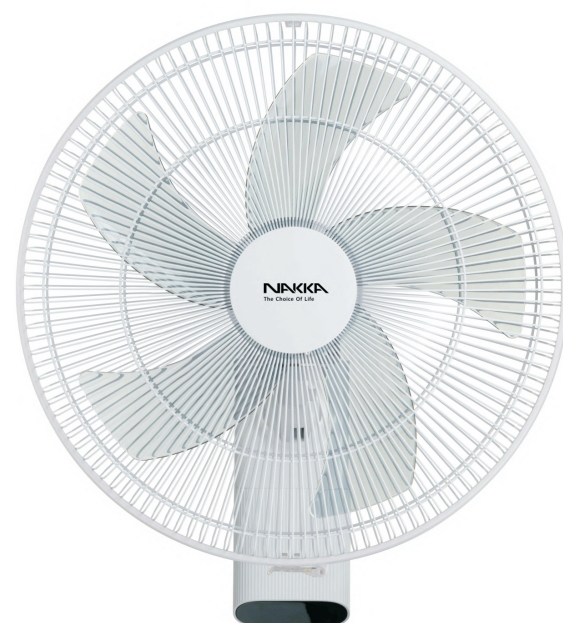

**INFRARED**

REMOTE CONTROL

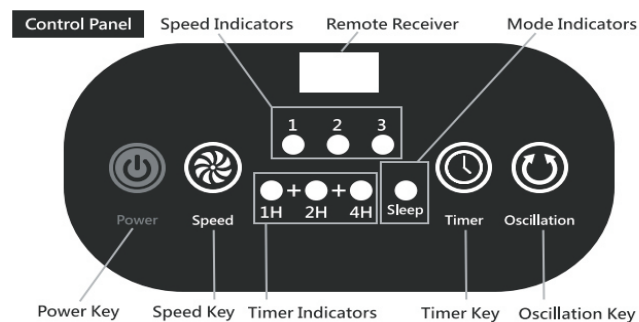

DC Frequency Conversion Fan

NANKA

Model: FS40-DC22ARL



|                     |  |
|---------------------|--|
| Size                | 16 INCH  |
| Rated power         | 30W  |
| Rated voltage(V)    | 200-240V/100-120V  |
| Control panel       | touched control panel  |
| Fan mode            | 9 wind speeds, 9h timer, strong wind mode, natural wind mode |
| Maximum wind volume | 68m³/s   |

|              |              |
|--------------|--------------|
| Gross weight | 6.62kg       |
| Net weight   | 5.73kg       |
| Packing size | 59*16*46.5cm |

|              |          |           |
|--------------|----------|-----------|
| Rotate speed | 1-550rpm | 4-900rpm  |
|              | 2-700rpm | 5-1050rpm |
|              | 3-750rpm | 6-1200rpm |

|                |      |
|----------------|------|
| 20 GP capacity | 600  |
| 40 GP capacity | 1420 |
| 40 HC capacity | 1500 |



**INFRARED**

REMOTE CONTROL

